

Data sheet | Item number: 788-304/003-000

Relay module; Nominal input voltage: 24 VDC; 1 changeover contact;  
 Limiting continuous current: 16 A; Red status indicator; Module width: 15 mm

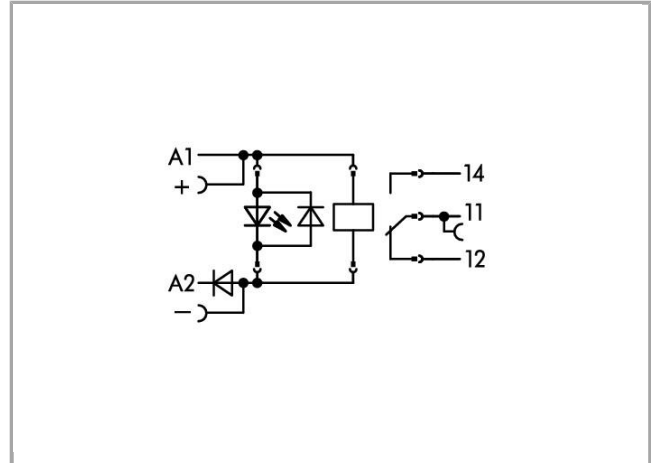

788-304/003-000

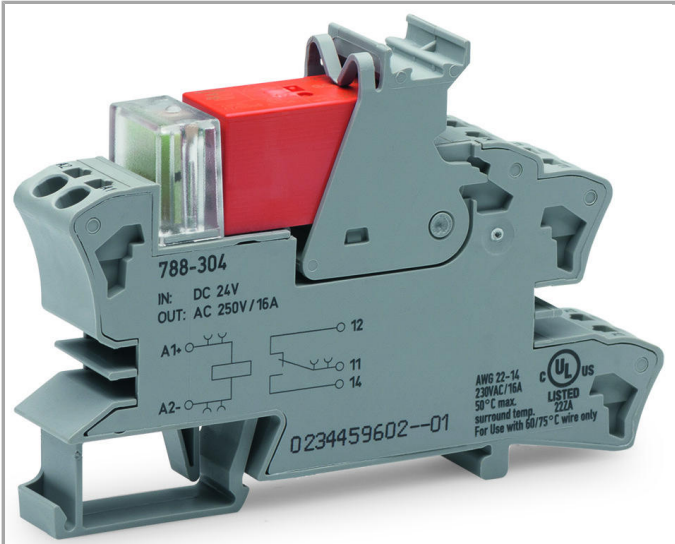

RoHS  Compliant

[BOMcheck.net](https://www.bomcheck.net)

Similar to picture

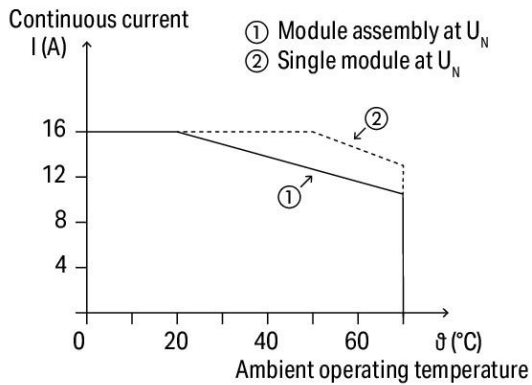

Current-carrying capacity curve

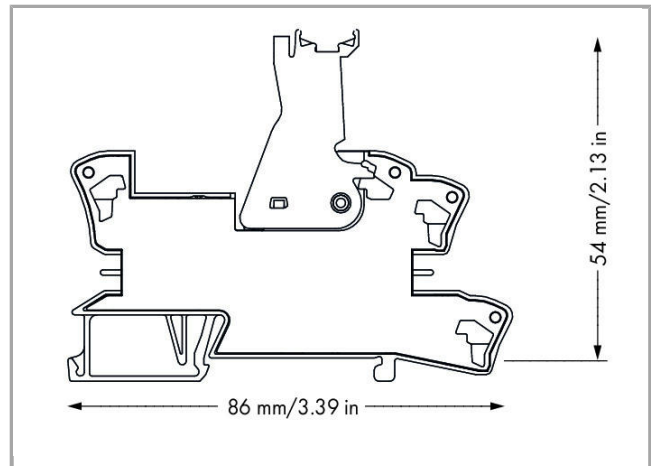

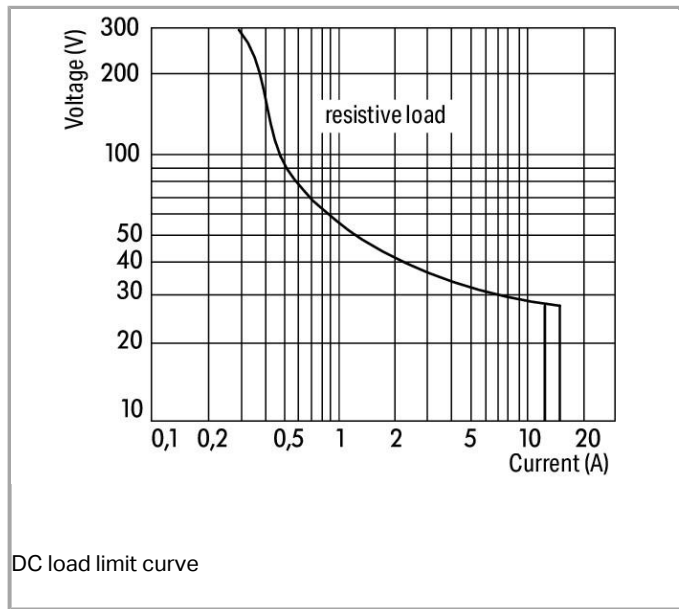

## Item description

### Note:

- Reinforced insulation between coil and contacts
- A separator plate (e.g., 209-191) must be used for voltages greater than 250 V between adjacent relay modules and for compliance with the reinforced insulation requirements.
- To protect the relay coils and contacts, inductive loads must be dampened with an effective protection circuit.

## Data

### Technical Data

#### Control circuit

Nominal input voltage $U_N$	DC 24 V
Input voltage range	-25 ... +30 %
Nominal input current at $U_N$	19 mA

#### Load circuit:

Number of changeover/switchover contacts	1
Contact material (relay)	AgNi 90/10
Limiting continuous current	16 A
Max. make current (resistive)	(AC) 30 A / 4 s
Max. switching voltage	AC 250 V
Max. switching power (resistive)	AC 4,000 VA; DC see load limit curve
Switching capacity	AC-15: 6 A / AC 250 V; DC-13: 2 A / DC 24 V



Recommended minimum load	12 V / 10 mA
Pull-in time (typ.)	8 ms
Drop-out time (typ.)	6 ms
Bounce time (typ)	6 ms
Electrical life (N.O.; resistive load; 23 °C)	30 x 10 <sup>3</sup> switching operations
Mechanical life (N.O.; resistive load; 23 °C)	30 x 10 <sup>6</sup> switching operations
Max. switching load with load/without load	6 min <sup>-1</sup> / 1,200 min <sup>-1</sup>

## Signaling

Status indication	LED red
-------------------	---------

## Safety and protection:

Rated voltage	250 V
Rated impulse voltage	4 kV
Pollution degree	3
Dielectric strength, control/load circuit (AC, 1 min)	5 kVrms
Dielectric strength open contact (AC, 1 min)	1 kVrms
Protection class	IP20

## Geometrical Data

Width	15 mm / 0.591 inch
Height from upper-edge of DIN-35 rail	54 mm / 2.126 inch
Depth	86 mm / 3.386 inch

## Material Data

Color	gray
-------	------

## Environmental Requirements

Surrounding air (storage) temperature	-40 ... 70 °C
Processing temperature	-25 ... +50 °C



## Standards and specifications

Standards/specifications	EN 61010-2-201; EN 61810-1; EN 61373; UL 508 (max. 10 A); DNV GL
--------------------------	--

## Approvals / Certificates

### Ship Approvals

Logo	Approval	Additional Approval Text	Certificate name

	<b>DNV GL</b> Det Norske Veritas, Germanischer Lloyd	-	TAA00001D1
	<b>NK</b> Nippon Kaiji Kyokai	-	TA17255M
	<b>PRS</b> Polski Rejestr Statków	-	TE/2186 /880590/18

## UL-Approvals



Logo	Approval	Additional Approval Text	Certificate name
	<b>UL</b> UL International Netherlands B.V. (ORDINARY LOCATIONS)	UL 508	E175199 Sec.6
	<b>UL</b> UL International Netherlands B.V. (ORDINARY LOCATIONS)	UL 508	E175199 Sec.6

















## Compatible products















## General accessories















	<b>Item no.: 209-145</b> Group marker carrier	209-145
	<b>Item no.: 209-184</b> Protection cover	209-184
	<b>Item no.: 249-105</b> Group marker carrier	249-105















## ferrule















	<b>Item no.: 216-241</b> Ferrule; Sleeve for 0.5 mm <sup>2</sup> / 20 AWG; insulated; electro-tin plated; electrolytic copper; gastight crimped; acc. to DIN 46228, Part 4/09.90	216-241
	<b>Item no.: 216-242</b> Ferrule; Sleeve for 0.75 mm <sup>2</sup> / 18 AWG; insulated; electro-tin plated; electrolytic copper; gastight crimped; acc. to DIN 46228, Part 4/09.90	216-242
	<b>Item no.: 216-243</b> Ferrule; Sleeve for 1 mm <sup>2</sup> / AWG 18; insulated; electro-tin plated; electrolytic copper; gastight crimped; acc. to DIN 46228, Part 4/09.90	216-243

	<b>Item no.: 216-244</b> Ferrule; Sleeve for 1.5 mm <sup>2</sup> / AWG 16; insulated; electro-tin plated; electrolytic copper; gastight crimped; acc. to DIN 46228, Part 4/09.90	216-244
	<b>Item no.: 216-542</b> Twin ferrule; Sleeve for 2 x 1 mm <sup>2</sup> / AWG 2 x 18; red, insulated; 12 mm long	216-542
<b>tools</b>		
	<b>Item no.: 210-720</b> Operating tool with partially insulated shaft; Type 2, blade (3.5 x 0.5) mm	210-720
<b>Marking accessories</b>		
	<b>Item no.: 2009-110</b> Marking strips; on reel; not stretchable; plain; snap-on type	2009-110
	<b>Item no.: 2009-115</b> WMB-Inline; for Smart Printer; on reel; stretchable 5 - 5.2 mm; plain; snap-on type	2009-115
	<b>Item no.: 2009-115/000-002</b> WMB-Inline; for Smart Printer; on reel; stretchable 5 - 5.2 mm; plain; snap-on type	2009-115 /000-002
	<b>Item no.: 2009-115/000-006</b> WMB-Inline; for smartPRINTER; on reel; stretchable 5 - 5.2 mm; plain; snap-on type	2009-115 /000-006
	<b>Item no.: 2009-115/000-007</b> WMB-Inline; for Smart Printer; on reel; stretchable 5 - 5.2 mm; plain; snap-on type	2009-115 /000-007
	<b>Item no.: 2009-115/000-012</b> WMB-Inline; for smartPRINTER; on reel; stretchable 5 - 5.2 mm; plain; snap-on type	2009-115 /000-012
	<b>Item no.: 2009-115/000-017</b> WMB-Inline; for Smart Printer; on reel; stretchable 5 - 5.2 mm; plain; snap-on type	2009-115 /000-017
	<b>Item no.: 2009-115/000-023</b> WMB-Inline; for Smart Printer; on reel; stretchable 5 - 5.2 mm; plain; snap-on type	2009-115 /000-023
	<b>Item no.: 209-128</b> Adaptor	209-128
	<b>Item no.: 209-183</b> Marker card	209-183
	<b>Item no.: 210-110</b> Fiber-tip pen	210-110
	<b>Item no.: 793-501</b> WMB marking card; as card; not stretchable; plain; snap-on type	793-501
	<b>Item no.: 793-501/000-002</b> WMB marking card; as card; not stretchable; plain; snap-on type	793-501 /000-002

	<b>Item no.: 793-501/000-005</b> WMB marking card; as card; not stretchable; plain; snap-on type	/000-005	793-501
	<b>Item no.: 793-501/000-006</b> WMB marking card; as card; not stretchable; plain; snap-on type	/000-006	793-501
	<b>Item no.: 793-501/000-007</b> WMB marking card; as card; not stretchable; plain; snap-on type	/000-007	793-501
	<b>Item no.: 793-501/000-012</b> WMB marking card; as card; not stretchable; plain; snap-on type	/000-012	793-501
	<b>Item no.: 793-501/000-017</b> WMB marking card; as card; not stretchable; plain; snap-on type	/000-017	793-501
	<b>Item no.: 793-501/000-023</b> WMB marking card; as card; not stretchable; plain; snap-on type	/000-023	793-501
	<b>Item no.: 793-501/000-024</b> WMB marking card; as card; not stretchable; plain; snap-on type	/000-024	793-501
	<b>Item no.: 793-502</b> WMB marking card; as card; MARKED; 1 ... 10 (10x); not stretchable; Horizontal marking; snap-on type		793-502
	<b>Item no.: 793-502/000-002</b> WMB marking card; as card; MARKED; 1 ... 10 (10x); not stretchable; Horizontal marking; snap-on type	/000-002	793-502
	<b>Item no.: 793-502/000-005</b> WMB marking card; as card; MARKED; 1 ... 10 (10x); not stretchable; Horizontal marking; snap-on type	/000-005	793-502
	<b>Item no.: 793-502/000-006</b> WMB marking card; as card; MARKED; 1 ... 10 (10x); not stretchable; Horizontal marking; snap-on type	/000-006	793-502
	<b>Item no.: 793-502/000-007</b> WMB marking card; as card; MARKED; 1 ... 10 (10x); not stretchable; Horizontal marking; snap-on type	/000-007	793-502
	<b>Item no.: 793-502/000-012</b> WMB marking card; as card; MARKED; 1 ... 10 (10x); not stretchable; Horizontal marking; snap-on type	/000-012	793-502
	<b>Item no.: 793-502/000-017</b> WMB marking card; as card; MARKED; 1 ... 10 (10x); not stretchable; Horizontal marking; snap-on type	/000-017	793-502
	<b>Item no.: 793-502/000-023</b> WMB marking card; as card; MARKED; 1 ... 10 (10x); not stretchable; Horizontal marking; snap-on type	/000-023	793-502

	<b>Item no.: 793-502/000-024</b> WMB marking card; as card; MARKED; 1 ... 10 (10x); not stretchable; Horizontal marking; snap-on type / 000-024	793-502
	<b>Item no.: 793-503</b> WMB marking card; as card; MARKED; 11 ... 20 (10x); not stretchable; Horizontal marking; snap-on type	793-503
	<b>Item no.: 793-503/000-002</b> WMB marking card; as card; MARKED; 11 ... 20 (10x); not stretchable; Horizontal marking; snap-on type / 000-002	793-503
	<b>Item no.: 793-503/000-005</b> WMB marking card; as card; MARKED; 11 ... 20 (10x); not stretchable; Horizontal marking; snap-on type / 000-005	793-503
	<b>Item no.: 793-503/000-006</b> WMB marking card; as card; MARKED; 11 ... 20 (10x); not stretchable; Horizontal marking; snap-on type / 000-006	793-503
	<b>Item no.: 793-503/000-007</b> WMB marking card; as card; MARKED; 11 ... 20 (10x); not stretchable; Horizontal marking; snap-on type / 000-007	793-503
	<b>Item no.: 793-503/000-012</b> WMB marking card; as card; MARKED; 11 ... 20 (10x); not stretchable; Horizontal marking; snap-on type / 000-012	793-503
	<b>Item no.: 793-503/000-017</b> WMB marking card; as card; MARKED; 11 ... 20 (10x); not stretchable; Horizontal marking; snap-on type / 000-017	793-503
	<b>Item no.: 793-503/000-023</b> WMB marking card; as card; MARKED; 11 ... 20 (10x); not stretchable; Horizontal marking; snap-on type / 000-023	793-503
	<b>Item no.: 793-503/000-024</b> WMB marking card; as card; MARKED; 11 ... 20 (10x); not stretchable; Horizontal marking; snap-on type / 000-024	793-503
	<b>Item no.: 793-504</b> WMB marking card; as card; MARKED; 21 ... 30 (10x); not stretchable; Horizontal marking; snap-on type	793-504
	<b>Item no.: 793-504/000-002</b> WMB marking card; as card; MARKED; 21 ... 30 (10x); not stretchable; Horizontal marking; snap-on type / 000-002	793-504
	<b>Item no.: 793-504/000-005</b> WMB marking card; as card; MARKED; 21 ... 30 (10x); not stretchable; Horizontal marking; snap-on type / 000-005	793-504
	<b>Item no.: 793-504/000-006</b> WMB marking card; as card; MARKED; 21 ... 30 (10x); not stretchable; Horizontal marking; snap-on type / 000-006	793-504
	<b>Item no.: 793-504/000-012</b> WMB marking card; as card; MARKED; 21 ... 30 (10x); not stretchable; Horizontal marking; snap-on type / 000-012	793-504

	<b>Item no.: 793-504/000-017</b> WMB marking card; as card; MARKED; 21 ... 30 (10x); not stretchable; Horizontal marking; snap-on type	793-504
		/000-017
	<b>Item no.: 793-504/000-023</b> WMB marking card; as card; MARKED; 21 ... 30 (10x); not stretchable; Horizontal marking; snap-on type	793-504
		/000-023
	<b>Item no.: 793-505</b> WMB marking card; as card; MARKED; 31 ... 40 (10x); not stretchable; Horizontal marking; snap-on type	793-505
	<b>Item no.: 793-505/000-005</b> WMB marking card; as card; MARKED; 31 ... 40 (10x); not stretchable; Horizontal marking; snap-on type	793-505
		/000-005
	<b>Item no.: 793-505/000-006</b> WMB marking card; as card; MARKED; 31 ... 40 (10x); not stretchable; Horizontal marking; snap-on type	793-505
		/000-006
	<b>Item no.: 793-505/000-007</b> WMB marking card; as card; MARKED; 31 ... 40 (10x); not stretchable; Horizontal marking; snap-on type	793-505
		/000-007
	<b>Item no.: 793-505/000-012</b> WMB marking card; as card; MARKED; 31 ... 40 (10x); not stretchable; Horizontal marking; snap-on type	793-505
		/000-012
	<b>Item no.: 793-506</b> WMB marking card; as card; MARKED; 41 ... 50 (10x); not stretchable; Horizontal marking; snap-on type	793-506
	<b>Item no.: 793-506/000-005</b> WMB marking card; as card; MARKED; 41 ... 50 (10x); not stretchable; Horizontal marking; snap-on type	793-506
		/000-005
	<b>Item no.: 793-506/000-006</b> WMB marking card; as card; MARKED; 41 ... 50 (10x); not stretchable; Horizontal marking; snap-on type	793-506
		/000-006
	<b>Item no.: 793-506/000-012</b> WMB marking card; as card; MARKED; 41 ... 50 (10x); not stretchable; Horizontal marking; snap-on type	793-506
		/000-012
	<b>Item no.: 793-506/000-017</b> WMB marking card; as card; MARKED; 41 ... 50 (10x); not stretchable; Horizontal marking; snap-on type	793-506
		/000-017
	<b>Item no.: 793-5501</b> WMB marking card; as card; for terminal block width 5 - 17.5 mm; stretchable 5 - 5.2 mm; plain; snap-on type	793-5501
	<b>Item no.: 793-5501/000-002</b> WMB marking card; as card; for terminal block width 5 - 17.5 mm; stretchable 5 - 5.2 mm; plain; snap-on type	793-5501
		/000-002
	<b>Item no.: 793-5501/000-005</b> WMB marking card; as card; stretchable 5 - 5.2 mm; plain; snap-on type	793-5501
		/000-005

	<b>Item no.: 793-5501/000-006</b> WMB marking card; as card; stretchable 5 - 5.2 mm; plain; snap-on type	/000-006	793-5501
	<b>Item no.: 793-5501/000-007</b> WMB marking card; as card; stretchable 5 - 5.2 mm; plain; snap-on type	/000-007	793-5501
	<b>Item no.: 793-5501/000-012</b> WMB marking card; as card; stretchable 5 - 5.2 mm; plain; snap-on type	/000-012	793-5501
	<b>Item no.: 793-5501/000-014</b> WMB marking card; as card; stretchable 5 - 5.2 mm; plain; snap-on type	/000-014	793-5501
	<b>Item no.: 793-5501/000-017</b> WMB marking card; as card; stretchable 5 - 5.2 mm; plain; snap-on type	/000-017	793-5501
	<b>Item no.: 793-5501/000-023</b> WMB marking card; as card; stretchable 5 - 5.2 mm; plain; snap-on type	/000-023	793-5501
	<b>Item no.: 793-5501/000-024</b> WMB marking card; as card; stretchable 5 - 5.2 mm; plain; snap-on type	/000-024	793-5501
	<b>Item no.: 793-566</b> WMB marking card; as card; MARKED; 1 ... 50 (2x); not stretchable; Horizontal marking; snap-on type		793-566
	<b>Item no.: 793-566/000-002</b> WMB marking card; as card; MARKED; 1 ... 50 (2x); not stretchable; Horizontal marking; snap-on type	/000-002	793-566
	<b>Item no.: 793-566/000-005</b> WMB marking card; as card; MARKED; 1 ... 50 (2x); not stretchable; Horizontal marking; snap-on type	/000-005	793-566
	<b>Item no.: 793-566/000-006</b> WMB marking card; as card; MARKED; 1 ... 50 (2x); not stretchable; Horizontal marking; snap-on type	/000-006	793-566
	<b>Item no.: 793-566/000-007</b> WMB marking card; as card; MARKED; 1 ... 50 (2x); not stretchable; Horizontal marking; snap-on type	/000-007	793-566
	<b>Item no.: 793-566/000-012</b> WMB marking card; as card; MARKED; 1 ... 50 (2x); not stretchable; Horizontal marking; snap-on type	/000-012	793-566
	<b>Item no.: 793-566/000-017</b> WMB marking card; as card; MARKED; 1 ... 50 (2x); not stretchable; Horizontal marking; snap-on type	/000-017	793-566
	<b>Item no.: 793-566/000-023</b> WMB marking card; as card; MARKED; 1 ... 50 (2x); not stretchable; Horizontal marking; snap-on type	/000-023	793-566



**Item no.: 793-566/000-024** 793-566  
 WMB marking card; as card; MARKED; 1 ... 50 (2x); not stretchable; Horizontal marking; snap-on type /000-024

**Jumper**



**Item no.: 788-113** 788-113  
 Comb-style jumper bar; 2-way; insulated



**Item no.: 788-114** 788-114  
 Comb-style jumper bar; 3-way; insulated



**Item no.: 788-115** 788-115  
 Comb-style jumper bar; 4-way; insulated



**Item no.: 788-116** 788-116  
 Comb-style jumper bar; 6-way; insulated



**Item no.: 788-117** 788-117  
 Comb-style jumper bar; 8-way; insulated



**Item no.: 788-118** 788-118  
 Comb-style jumper bar; 2-way (1-3); insulated



**Item no.: 859-402** 859-402  
 Push-in type jumper bar; 2-way; Nominal current 18 A; insulated



**Item no.: 859-402/000-005** 859-402  
 Push-in type jumper bar; 2-way; Nominal current 18 A; insulated /000-005



**Item no.: 859-402/000-006** 859-402  
 Push-in type jumper bar; 2-way; Nominal current 18 A; insulated /000-006



**Item no.: 859-402/000-029** 859-402  
 Push-in type jumper bar; 2-way; Nominal current 18 A; insulated /000-029

**Downloads**

**Documentation**

**Instruction Leaflet**

Socket with Relay or SSR pdf  
2.1 MB Download

**Additional Information**

Disposal; Electrical and electronic equipment, Packaging V 1.0.0 pdf  
265.8 kB Download



Subject to changes.

---